

# MAIN FRAME

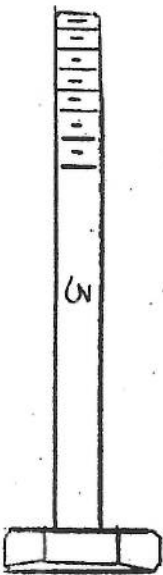

# TANK

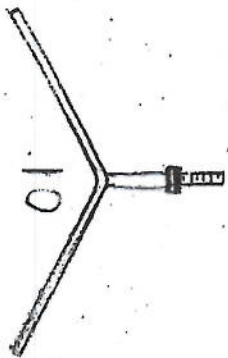
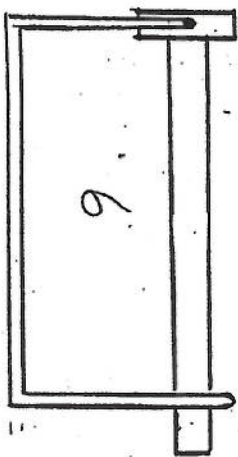
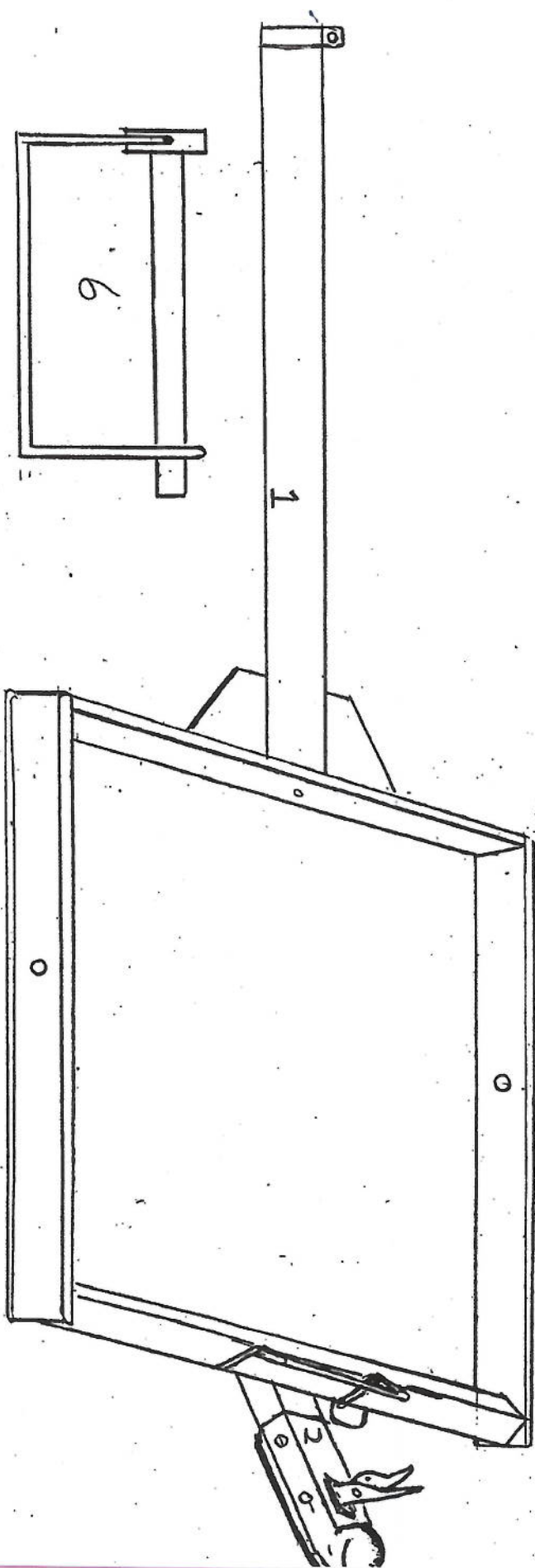
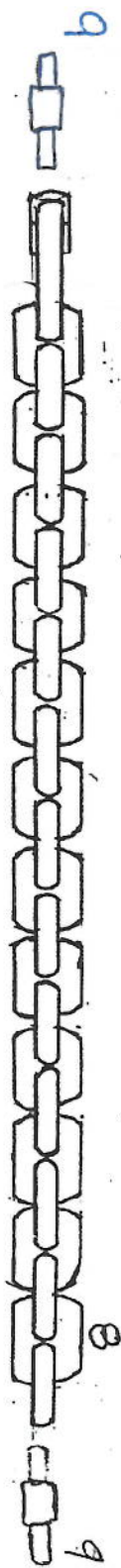
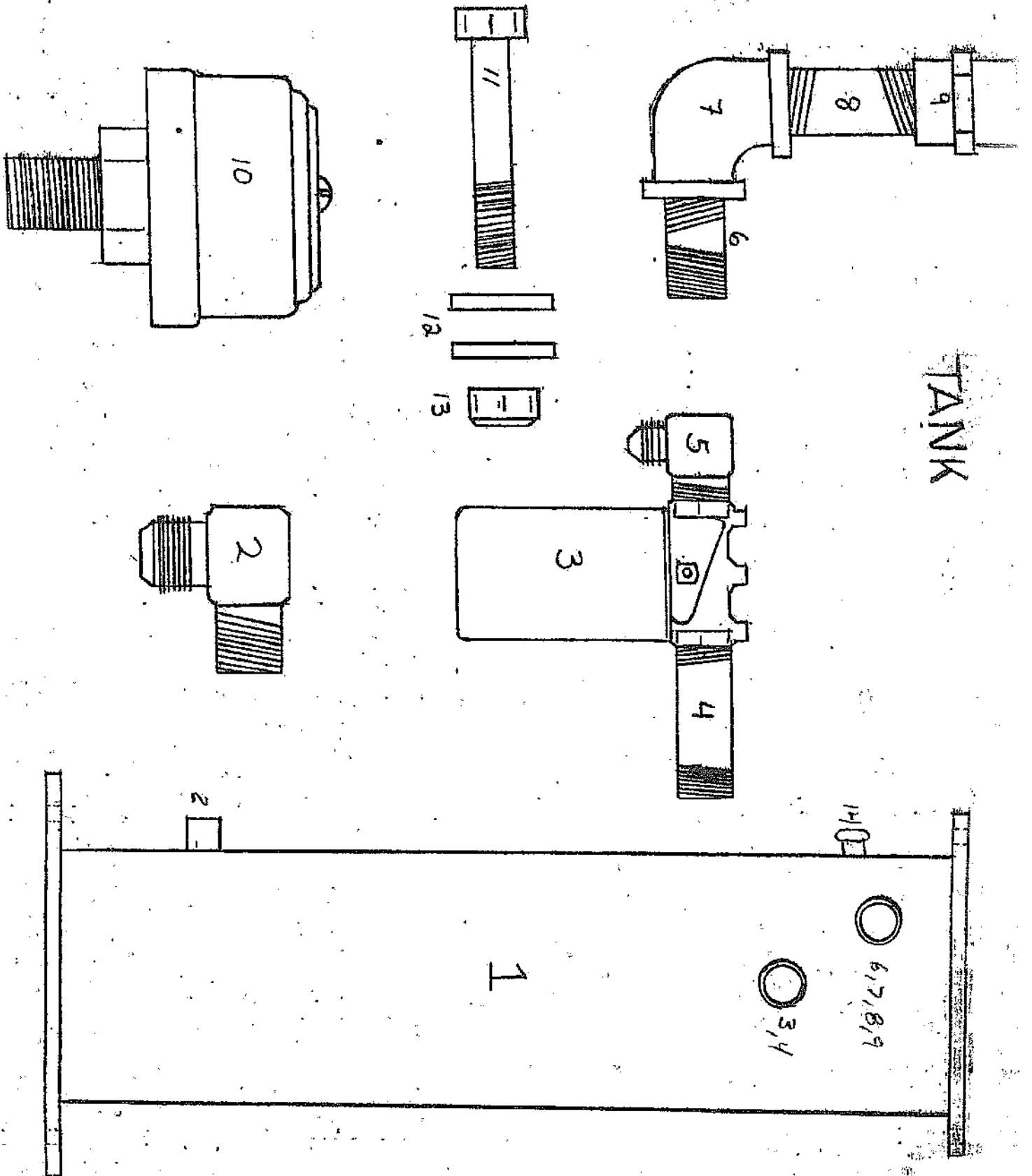

# ENGINE CRADLE AND PUMP

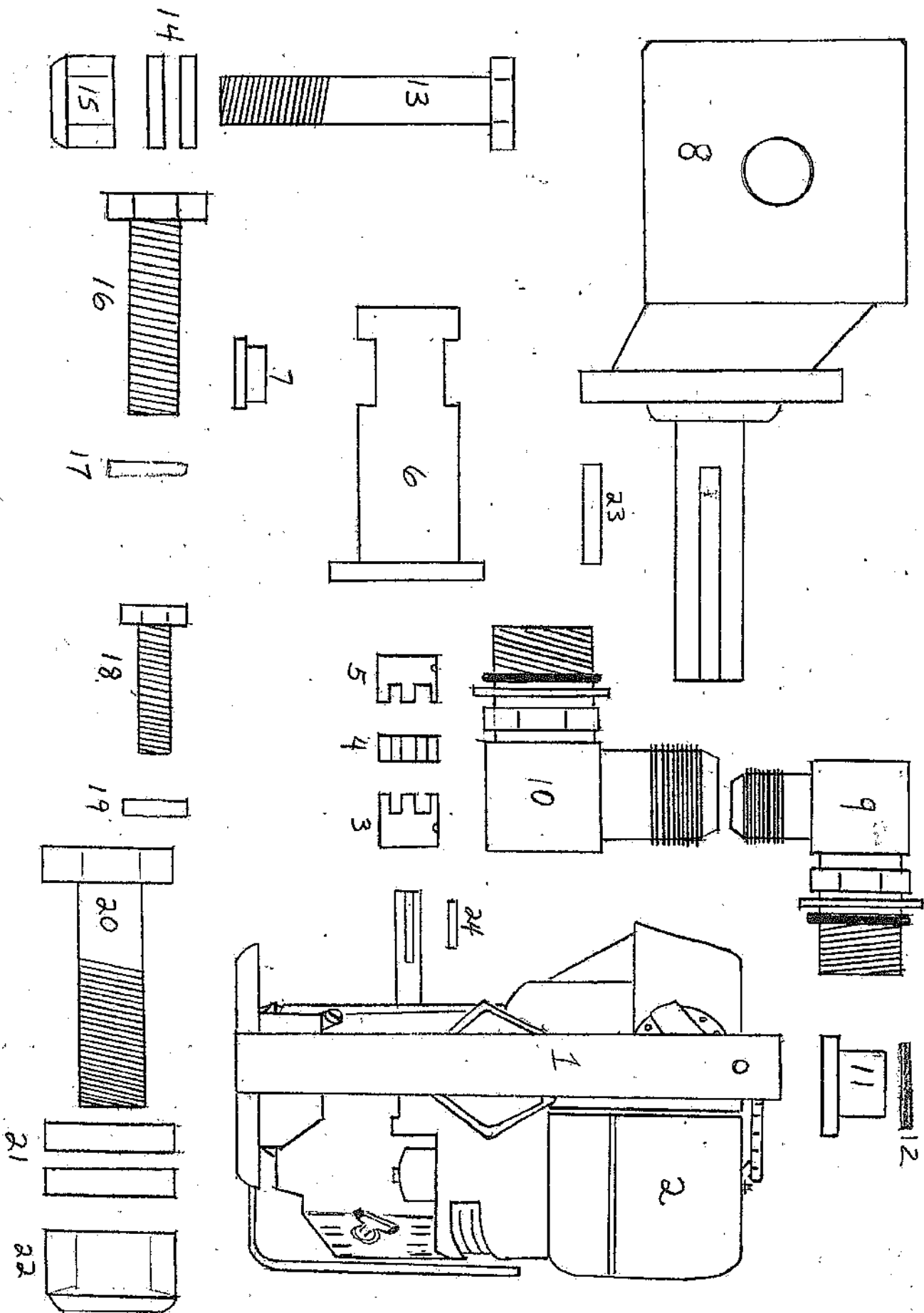

# HANDLE 1

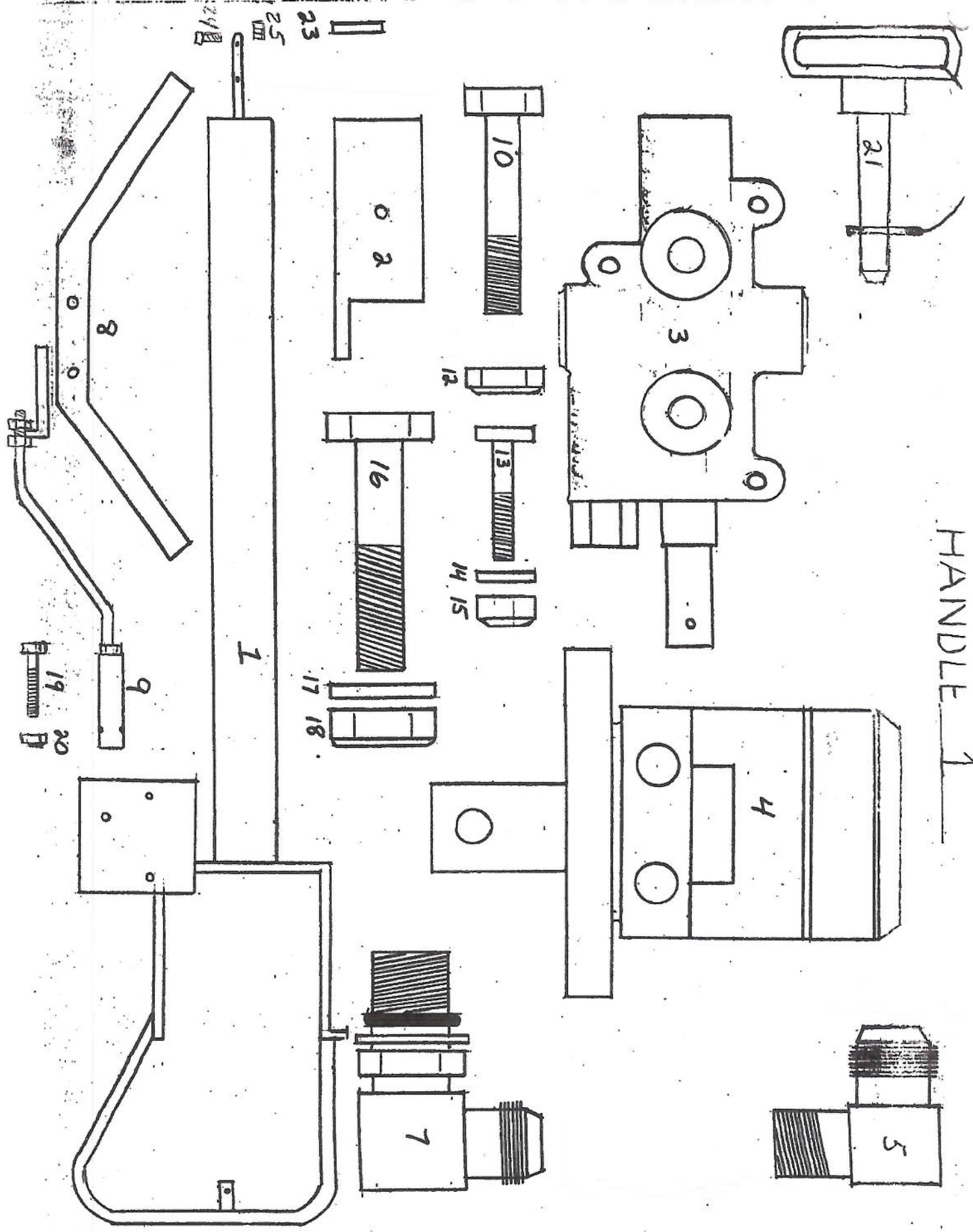

HOSES

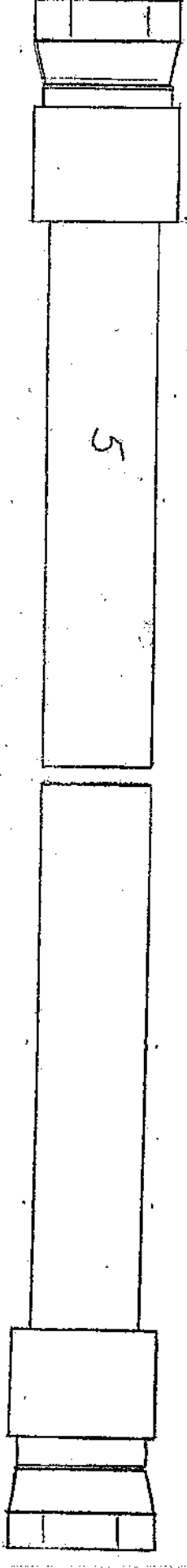
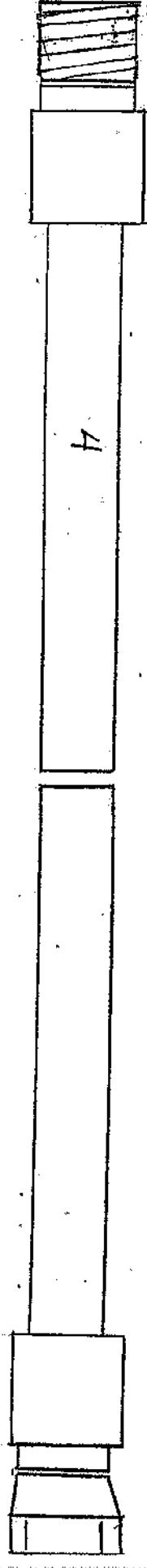
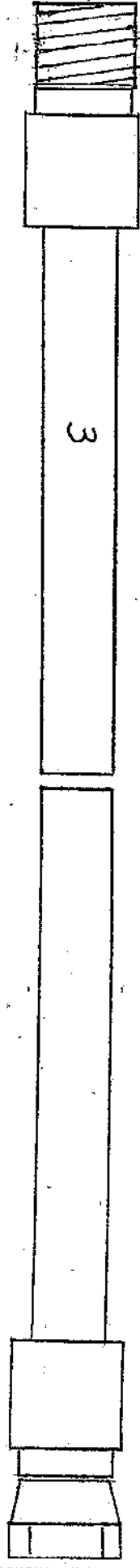
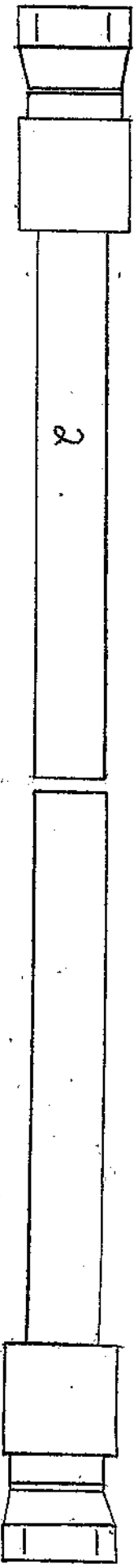
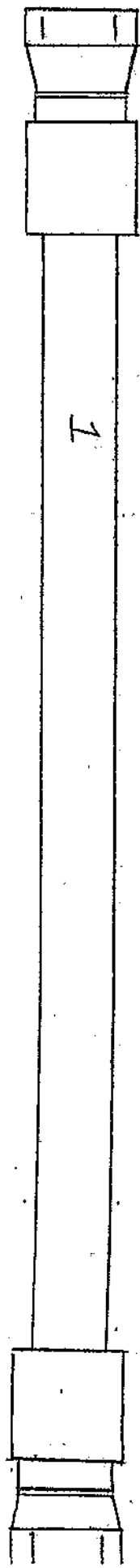

# AXLE AND AXLE TUBE

